

Revision Level			Revision Record	Changed	Date	Approved	Date
Drawing	State	Part					
02.1	Design Release	-	SEE ECN# 014656	NHK	09/19/18	EJH	09/19/18

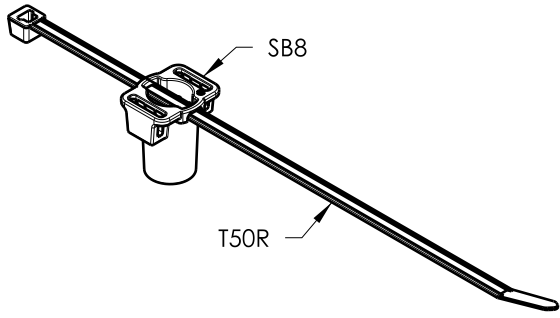

ASSEMBLED EXAMPLE VIEW
OPTION 1
SCALE 1:2

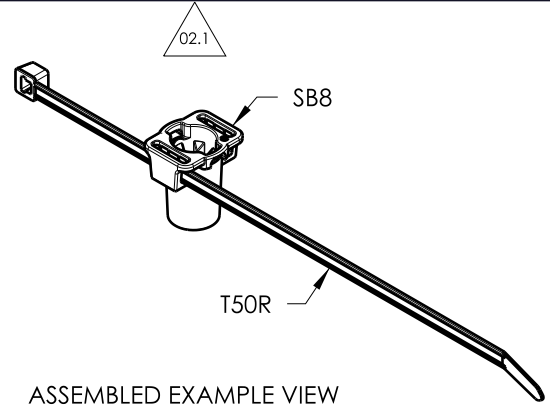

ASSEMBLED EXAMPLE VIEW
OPTION 2
SCALE 1:2

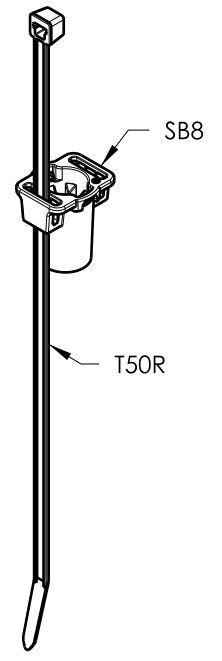

ASSEMBLED EXAMPLE VIEW
OPTION 3
SCALE 1:2

SB8
DELIVERY CONDITION: UNASSEMBLED SET

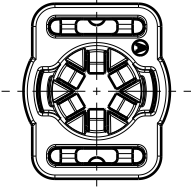

T50R
DELIVERY CONDITION: UNASSEMBLED SET

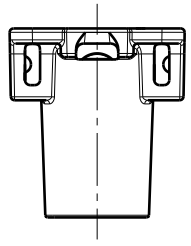
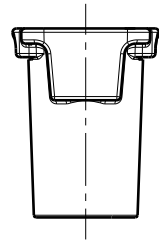
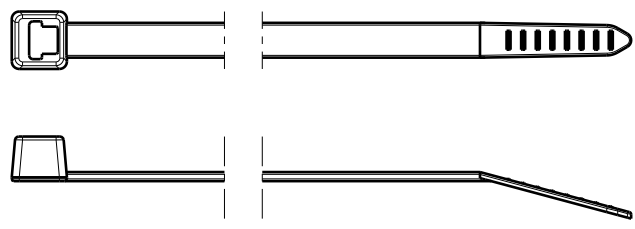

02.1

GLOBAL PART DESCRIPTION	BUNDLE RANGE	CABLE TIES		MOUNT	
		DRAWING	MATERIAL	DRAWING	MATERIAL
T50ROS8-SET-PA66HS/PA66HIRHSUV-BK	4 TO 50	CT2050007CST	PA66HS	14-0601-001-CSU	PA66HIRHSUV

Material SEE CHART	Units	millimeters	The copyright of this drawing is reserved by HellermannTyton. It is issued on condition that it is not reproduced, copied or disclosed to a third party, either wholly or in part, without the consent of HellermannTyton.	Drawn	KVH	12/22/14	Article/Type-No	SEE CHART	Scale	1:1
	Tolerance defined on each dimension	Approved		EJH	12/22/14	Title	8mm STUD MOUNT WITH T50R CABLE TIE		Project Number	14-0601
					Drawing-No	PRODUCTION : Phase		Format	AH	
					14-0601-101-CSU			Sheet	1/1	

North America
Email: corp@htamericas.com
Web: www.hellermann.tyton.com